

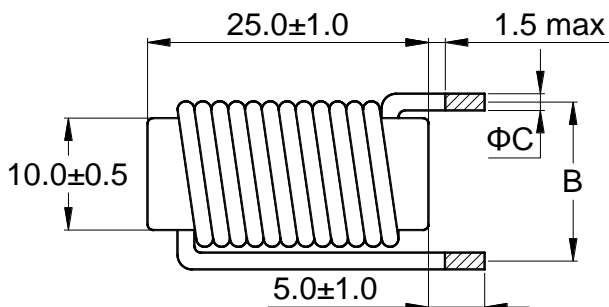

### Outline: 产品概要

- Use ferrite core, high frequency.  
铁氧体磁芯，工作频率高。
- Low DC resistance, high saturation current.  
低直流电阻，高饱和电流。
- Lead free product, RoHS compliant.  
无铅产品，符合 RoHS 指令。
- Widely used in switching power supply, power amplifier, output antenna, filter, display, UPS, and etc.  
广泛应用于开关电源，功率放大器，输出天线，滤波器，显示器，不间断电源等。
- Operating temperature :  $-40^{\circ}\text{C} \sim +125^{\circ}\text{C}$   
(Including coil's temperature rise)  
工作温度： $-40^{\circ}\text{C} \sim +125^{\circ}\text{C}$  (包含线圈发热)

### 1 Appearance and dimensions (mm) 外形尺寸



### 2 Schematic 原理图

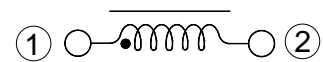
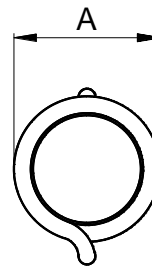

### 3 Reference hole pattern (mm) 参考焊孔尺寸

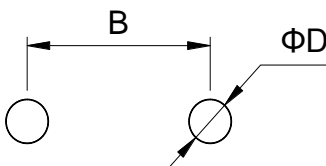

Part No. 型号	A	B	C	D
	Max	±1.0	±0.15	Ref.
3R3	13.7	17.0	1.50	1.90
4R7	13.5	16.5	1.40	1.80
5R6	13.3	16.0	1.30	1.70
6R8	12.9	15.0	1.10	1.50
8R2	12.9	15.0	1.10	1.50
100	12.7	14.5	1.00	1.40
150	12.5	14.5	0.90	1.30

**4 Electrical characteristics**

**电气特性**

Part No. 品名	Inductance (μH) 电感值 ※1 ±20%	D.C.R. (mΩ) 直流电阻		Saturation current (A) 饱和电流 ※2 Typical	Temperature rise current (A) 温升电流 ※3 Typical
		Typical	Max		
RKR1025-3R3M	3.30	3.30	4.40	60.0	25.5
RKR1025-4R7M	4.70	4.67	6.06	52.0	21.4
RKR1025-5R6M	5.60	5.81	7.56	48.0	19.2
RKR1025-6R8M	6.80	8.80	11.4	42.0	15.6
RKR1025-8R2M	8.20	10.2	13.2	40.0	14.5
RKR1025-100M	10.0	12.9	16.8	35.0	12.9
RKR1025-150M	15.0	21.0	26.5	28.0	10.4

■ All data is tested based on 25°C ambient temperature.

所有数据基于环境温度 25°C条件下测试。

※1 Inductance measure condition at 1kHz, 0.25V.

电感测试条件为 1kHz, 0.25V。

※2 Saturation current: the actual value of DC current when the inductance decrease 20% of its initial value.

饱和电流: 电感值下降其初始值的 20%时所加载的实际直流电流值。

※3 Temperature rise current: the actual value of DC current when the temperature rise is ΔT40°C(Ta=25°C).

温升电流: 使产品温度上升到 ΔT40°C时所加载的实际直流电流值(Ta=25°C)。

※ Special remind: Circuit design, component placement, PWB size and thickness, cooling system and etc.

all will affect the product temperature. Please verify the product temperature in the final application.

特别提醒: 线路设计, 组件布局, 印刷电路板(PWB)尺寸及厚度, 散热系统等均会影响产品温度。

请务必在最终应用时, 验证产品发热状况。

**5 Saturation current VS temperature rise current curve  
饱和电流 VS 温升电流曲线**

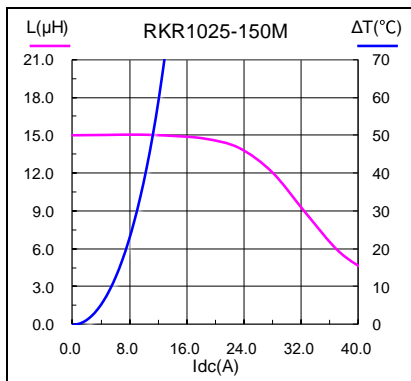
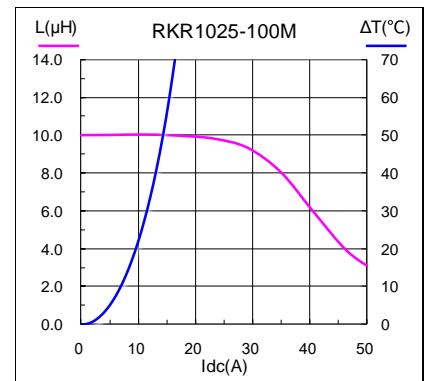
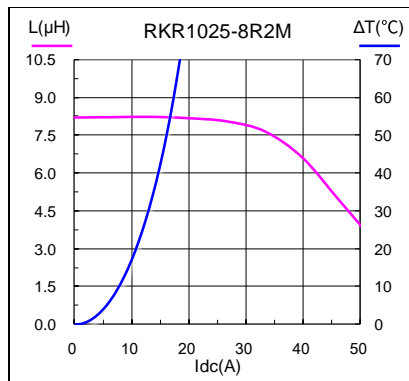
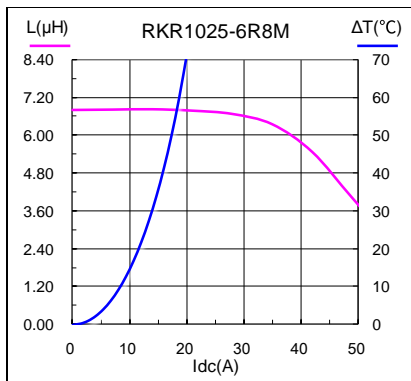
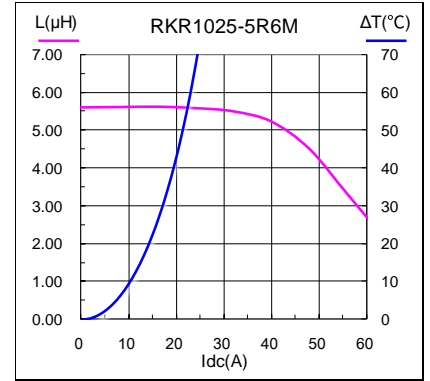
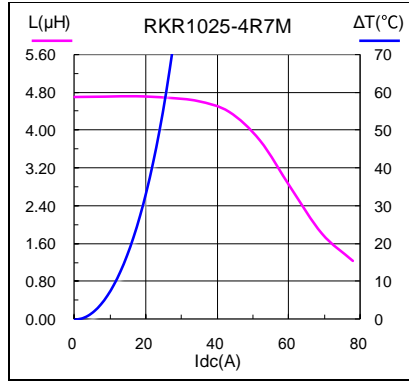
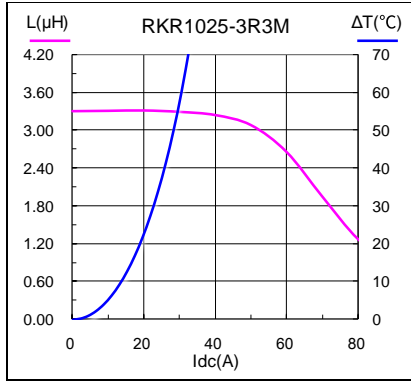

## 6 Packing specification

### 包装规格

#### 6.1 Packing

##### 包装

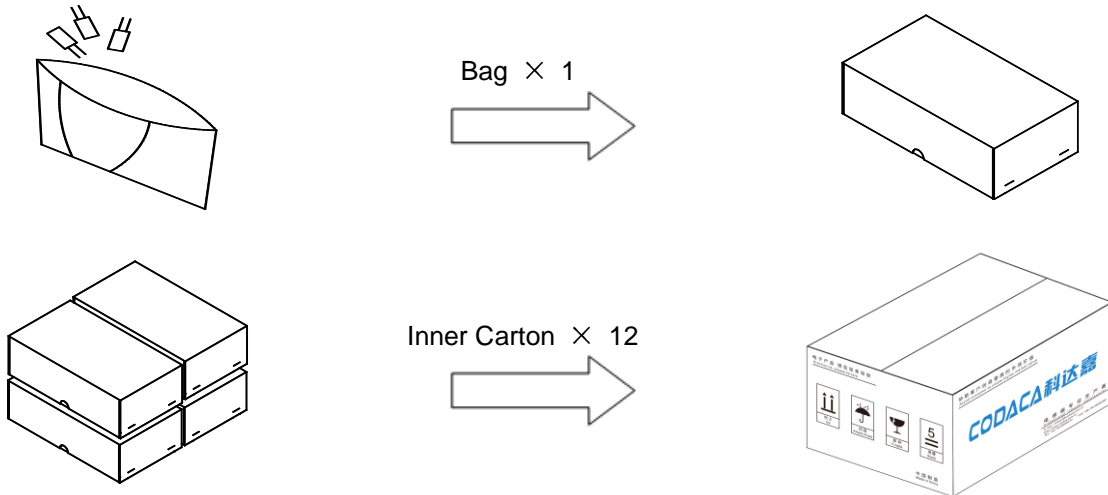

#### 6.2 Carton dimensions and packing quantity

##### 包装箱尺寸和包装数量

■ Inner Carton: 145×125×55mm  
内包装盒

■ Out Carton : 320×290×200mm  
外包装箱

Product Series 产品系列	Quantity / Bag 数量 / 袋	Inner Carton Quantity 内盒 包装数量	Out Carton Quantity 外箱 包装总数量
RKR1025	35pcs	(35×1) = 35pcs	(35×12) = 420pcs

#### 6.3 Label making

##### 标签标识

The following items will be marked on the bag of product label and shipping label.

以下项目将明确标识于产品包装袋标签以及运输标签上。

Production Label 产品标签
■ Part No. 产品型号
■ Electrical Information 产品电性信息
■ Quantity 数量
■ Packing No. 包装流水号

Shipping Label 运输标签
■ Customer Name 客户名称
■ Customer Part No. 客户型号
■ Supplier Part No. 供应商型号
■ Supplier Name 供应商名称
■ Country of origin 产品产地