

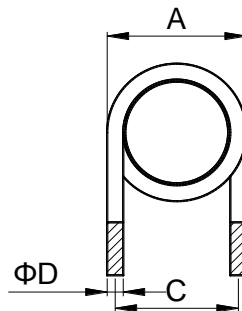

Outline: 产品概要

- Use ferrite core, high frequency.
铁氧体磁芯，工作频率高。
- Low DC resistance, high saturation current.
低直流电阻，高饱和电流。
- Lead free product, RoHS compliant.
无铅产品，符合 RoHS 指令。
- Widely used in switching power supply, power amplifier, output antenna, filter, display, UPS, and etc.
广泛应用于开关电源，功率放大器，输出天线，滤波器，显示器，不间断电源等。
- Operating temperature : $-40^{\circ}\text{C} \sim +125^{\circ}\text{C}$
(Including coil's temperature rise)
工作温度： $-40^{\circ}\text{C} \sim +125^{\circ}\text{C}$ (包含线圈发热)

1 Appearance and dimensions (mm) 外形尺寸

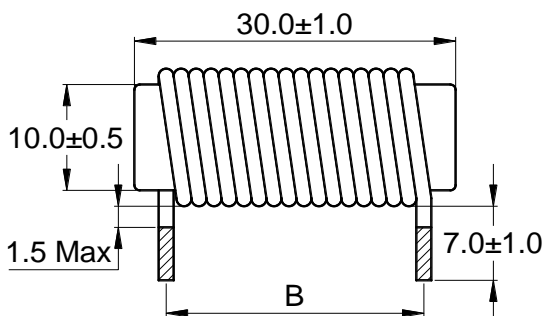

2 Schematic 原理图

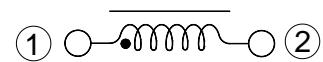

3 Reference hole pattern (mm) 参考焊孔尺寸

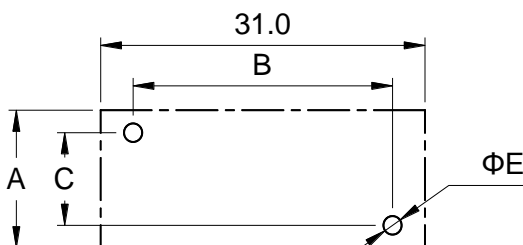

Part No. 型号	A	B	C	D	E
	Max	± 1.0	± 0.5	± 0.15	Ref.
8R2	14.5	25.5	12.0	1.60	2.00
100	14.0	22.5	11.7	1.30	1.70
150	13.5	24.0	11.5	1.10	1.50
220	13.5	28.0	11.4	1.00	1.40

4 Electrical characteristics

电气特性

Part No. 品名	Inductance (μH) 电感值 ※1 ±20%	D.C.R. (mΩ) 直流电阻		Saturation current (A) 饱和电流 ※2 Typical	Temperature rise current (A) 温升电流 ※3 Typical
		Typical	Max		
RAR1030-8R2M	8.20	4.95	6.43	31.0	21.6
RAR1030-100M	10.0	7.83	10.2	28.0	17.2
RAR1030-150M	15.0	13.7	17.8	23.5	13.0
RAR1030-220M	22.0	20.3	26.4	19.5	10.7

■ All data is tested based on 25°C ambient temperature.

所有数据基于环境温度 25°C条件下测试。

※1 Inductance measure condition at 1kHz, 0.25V.

电感测试条件为 1kHz, 0.25V。

※2 Saturation current: the actual value of DC current when the inductance decrease 20% of its initial value.

饱和电流: 电感值下降其初始值的 20%时所加载的实际直流电流值。

※3 Temperature rise current: the actual value of DC current when the temperature rise is ΔT40°C(Ta=25°C).

温升电流: 使产品温度上升到 ΔT40°C时所加载的实际直流电流值(Ta=25°C)。

※ Special remind: Circuit design, component placement, PWB size and thickness, cooling system and etc.

all will affect the product temperature. Please verify the product temperature in the final application.

特别提醒: 线路设计, 组件布局, 印刷电路板(PWB)尺寸及厚度, 散热系统等均会影响产品温度。

请务必在最终应用时, 验证产品发热状况。

**5 Saturation current VS temperature rise current curve
饱和电流 VS 温升电流曲线**

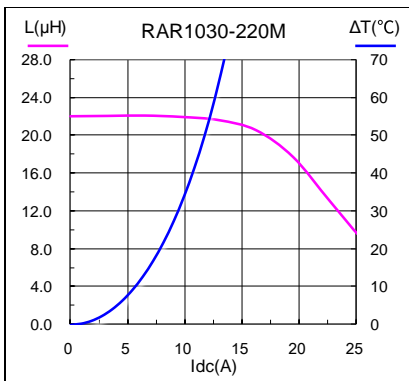
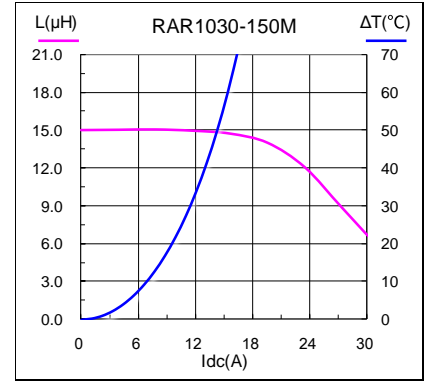
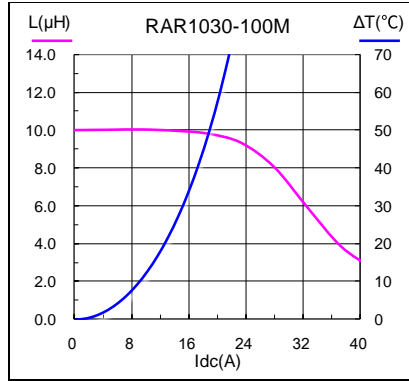
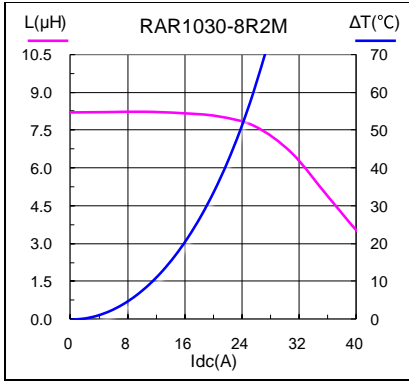

6 Packing specification

包装规格

6.1 Packing

包装

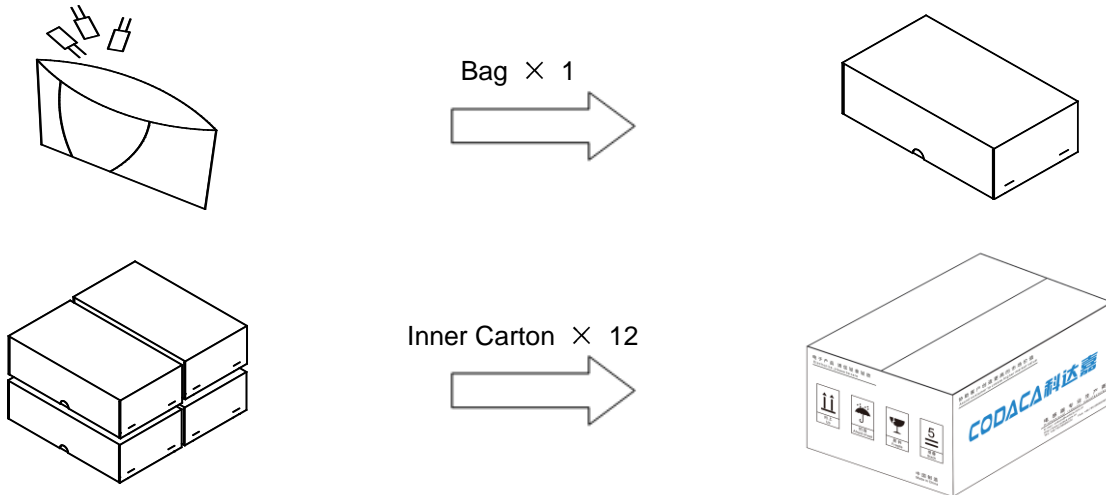

6.2 Carton dimensions and packing quantity

包装箱尺寸和包装数量

■ Inner Carton: 145×125×55mm
内包装盒

■ Out Carton : 320×290×200mm
外包装箱

Product Series 产品系列	Quantity / Bag 数量 / 袋	Inner Carton Quantity 内盒 包装数量	Out Carton Quantity 外箱 包装总数量
RAR1030	35pcs	(35×1) = 35pcs	(35×12) = 420pcs

6.3 Label making

标签标识

The following items will be marked on the bag of product label and shipping label.

以下项目将明确标识于产品包装袋标签以及运输标签上。

Production Label 产品标签
■ Part No. 产品型号
■ Electrical Information 产品电性信息
■ Quantity 数量
■ Packing No. 包装流水号

Shipping Label 运输标签
■ Customer Name 客户名称
■ Customer Part No. 客户型号
■ Supplier Part No. 供应商型号
■ Supplier Name 供应商名称
■ Country of origin 产品产地